

SECTION A-A  
SCALE 1 : 15

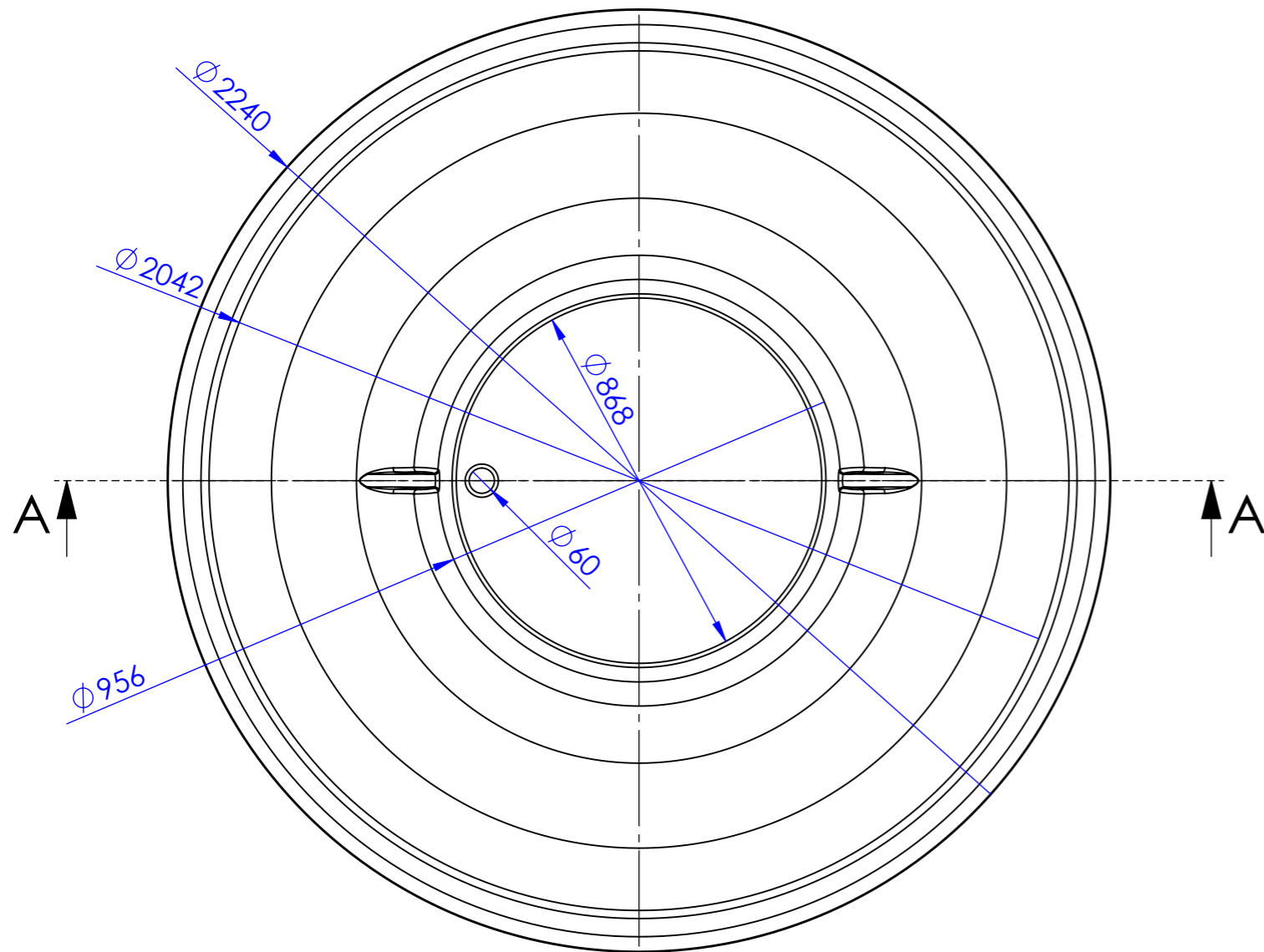
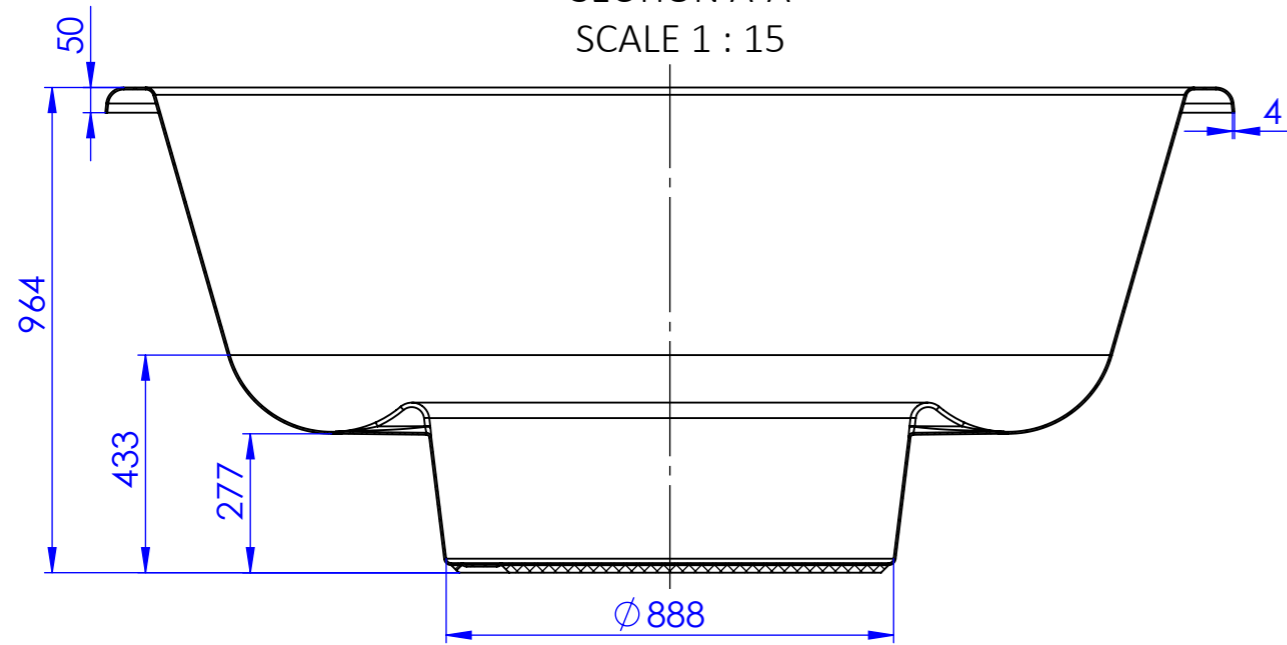

	Byla, laikmena	Papildoma informacija	Medžiaga stiklplasčio laminatas	Mastelis 1:15
Atsakinga žinyba Gamybos cechas	Konsultantas Vydas Vektaris	Dokumento tipas Gaminio brėžinys	Dokumento statusas Darbinis	
	Rengė Almontas Vilutis	Antraštė <b>KUBILO ĮDĖKLAS RYTIS Ø 2.2 M</b>	Žymuo PPL.KUB.00.002	
	Tvirtino Ričardas Koženiauskas		Laida 0	Data 2023 09 18
			Lapas 1/1	